

# SPECIFICATION FOR APPROVAL

## 產品確認書/製品仕様書

FILE SERIAL NO./檔序號:	XSG20230808003-T01
CUSTOMER / 客 戶:	
ARTICLE / 品 名:	SWITCHING POWER SUPPLY/CHARGER
MODEL NO. / 機種型號:	XSG14610000
PARAMETER / 規 格:	14.6V10.0A
CERTIFICATE/認證:	UL cUL CE FCC UKCA GS PSE SAA RCM
ISSUE DATE / 發行日期:	2023/8/8

Please to sign back after you confirm

承認書確認後請回簽一份

この仕様書をご確認とご署名の上、対象の営業窓口にご返信いただきますよう宜しくお願い致します。

CUSTOMER AUTHORIZED 客戶確認		
Approved by	Checked by	Prepared by

SUPPLIER AUTHORIZED 供方確認		
Approved by	Checked by	Prepared by
李麗敏	賀子豐	張文娟

\*感謝您的支持，我們十分珍惜每次合作機會

\*Thank you for your support, we will treasure the opportunity to cooperate with you

Rev.版本	Description of change/ 變更內容描述		Changed Date 日期	Approved
	Before(變更前)	After/變更後		
A	Original Release(初次發行)		2023/8/8	張文娟



- \* Make practical and safe power supply, Be enterprise with honesty and responsibility
- \* 提供實用安全的電源，做誠信負責的企業
- \* 実用的、安全な電源を提供し、誠実と信用、責任を持つ企業。



## ELECTRICAL PERFORMANCE / 電器性能

### 1.SAFETY STANDARD / 安規標準

- 1.1 The green mode power supply shall be certified by the following international regulatory standards: 充電器應符合下列的國際標準：

Certificate 證書	Country 國家	Standard/安規標準	Certificate 證書	Country 國家	Standard/安規標準
<input checked="" type="checkbox"/> UL/cUL	USA/CA 北美	UL62368-1; CAN/CSA C22.2 No62368-1 UL1310-1	<input checked="" type="checkbox"/> FCC	USA	47 CFR FCC Part 15
<input checked="" type="checkbox"/> LVD/ GS	Germany 德國	EN62368	<input checked="" type="checkbox"/> CE	Europe 歐洲	EN55032;EN55035;
<input checked="" type="checkbox"/> CB	Global 全球	IEC62368;IEC61558; IEC60335	<input type="checkbox"/> KC	Korea 韓國	K60950-1
<input checked="" type="checkbox"/> PSE	Japan 日本	J62368-1(2020) J3000(H25) J55032(H29) J60335-1	<input checked="" type="checkbox"/> SAA/RCM	AU 澳洲	AS/NZS 62368.1:2018 AS/NZS 60335
<input type="checkbox"/> CCC	CN 中國	GB 17625.1-2012;GB 4943.1-2011;GB/T 9254- 2008	<input checked="" type="checkbox"/> LVD / UKCA	Eu / UK 歐盟 英國	EN62368,BS EN 62368 EN61558

### 2.INPUT FEATURE / 輸入特性

- 2.1 INPUT VOLTAGE RANGE: 90Vac to 264Vac. 輸入電壓範圍可以從90Vac到264Vac.
- 2.2 RATED INPUT VOLTAGE: 100Vac to 240Vac. 額定輸入電壓從100Vac到240Vac.
- 2.3 INPUT FREQUENCY RANGE: 47Hz to 63Hz. 輸入頻率範圍從47Hz到63Hz.
- 2.4 INPUT CURRENT: **3.0A** max.&100-240Vac. 最大輸入電流**3.0A** (輸入條件100-240Vac)
- 2.5 INRUSH CURRENT: 60A max. at 100-240Vac input for a cold start at 25°C.在准開機條件下，最大浪湧電流不超過60A (輸入條件100-240Vac).
- 2.6 EFFICIENCY: higher than 87% at 100-240Vac input and output full load. 效率高於87% (輸入100-240Vac 和輸出滿載條件)。
- 2.7 No-Load Input Power Dissipation/輸入空載功率損耗: Input 115Vac or 230Vac,output no load, the input power loss is less than 0.5W. 輸入115/230V交流，在空載時，輸入功耗小於0.5W.

### 3.OUTPUT/輸出特性

Charging Status 充電狀態	Charging Stage 充電階段	Output current 輸出電流(A)	Output voltage 輸出電壓(V)	LED indicator 指示燈
1.Charging 充電中	Constant Current 恒流	10A±0.2A	8V-14.6V±0.3V	Red
	Constant Voltage 恒壓	10A >1.0A	14.6V	Red
2.Charged full 充滿	Trickle Charging 涓流	1.0A >0	14.6V	Green

### 4.Work Status of LED indicator/LED燈工作狀態顯示

- No load output:Green Light 空載輸出:綠燈 
- In Process of Charging:Red Light 充電中:紅燈 
- Charged Full: Green Light 充滿:綠燈 

<b>EDITION</b>	<b>A</b>	<b>PAGE</b>	<b>3/10</b>
----------------	----------	-------------	-------------

5.CHARGING CURVE/充電曲線圖：

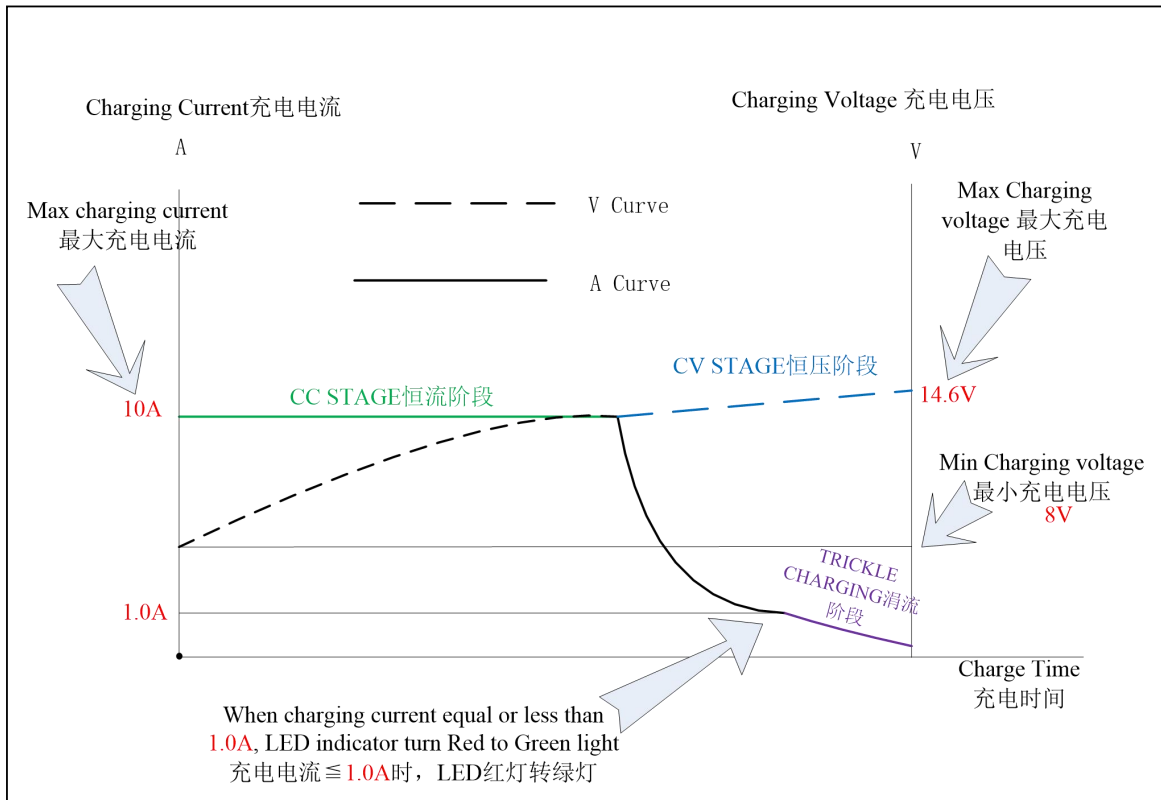

6.PROTECTION FEATURE / 保護特性

6.1 OVER – CURRENT PROTECTION / 過電流保護：

The green mode power supply shall be hiccup when any output operating in overload condition (set@ Max load 100~180% ) under any line condition for an indefinite period of time. The power supply shall be self – recovery when the fault condition is removed. 在任何時候任何輸入條件，當輸出操作在超載條件最大充電器的（100~180%）時，充電器將進入打嗝模式，當故障被移走後，充電器要能自動恢復到正常

6.2 SHORT – CIRCUIT PROTECTION / 輸出短路保護：

The power supply shall be hiccup and no damage shall occur when any output operating in a short circuit condition under any line condition for an indefinite period of time. The power supply shall be self recovery when the fault condition is removed. 在任何時候，任何輸入條件下，當輸出操作在短路情況下，充電器將進入打嗝模式，當故障消失後，充電器要能自動恢復正常。

6.3 REVERSE POLARITY PROTECTION/防反接保護(Optional)

6.3.1. To use Fool-Proof type DC plug. 建議使用防呆式設計的DC連接頭

6.3.2. When Connect wrong polarity, the charger will be self-recovery when fault condition is removed. this function is optional, customer could choose it in according to real requirement.

EDITION	A	PAGE	4/10
---------	---	------	------

## ELECTRICAL PERFORMANCE / 電器性能

當錯誤操作，反向連接時，充電器進入保護狀態，直到故障解除。此為選配功能，客戶可根據實際情況選擇。

### 7. ENVIRONMENTAL CONDITIONS / 環境條件

#### 7.1 OPERATING / 操作條件：

The power supply shall be capable of operating continuously in any mode without performance deterioration in the following environmental conditions. 在下列環境條件下，充電器要能夠連續操作在各種模式，且不能造成性能的退化。

7.1.1 **Operation Temperature: -20°C ~ 40°C 工作溫度: -20°C ~ 40°C**

7.1.2 **Relative Humidity: 10% ~ 90% 相對濕度: 10% ~ 90%**

7.1.3 **Vibration: 1.0mm, 10–25Hz, 15 minutes per cycle for each axis (X, Y, Z)**

7.1.4 **Cooling:** The power supply will operate with convection cooling. Blocking of vents must not cause damage to The power supply. 充電器將操作在對流冷卻的環境下，即使將通風口阻塞充電器也不允許有任何損傷發生。

#### 7.2 NON-OPERATING / 非操作條件：

The power supply shall be capable of withstanding the following environmental conditions extended periods of time, without sustaining electrical or mechanical damage and subsequent operational deficiencies:

充電器要能夠長期的經受下列的環境條件，且不允許有電氣級機械方面的損傷和併發的操作的缺失

7.2.1 **Storage Temperature: -30°C ~ 70°C 儲存溫度: -30°C ~ 70°C**

7.2.2 **Relative Humidity: 10% ~ 90% 相對濕度: 10% ~ 90%**

7.2.3 **Color of case and cable / 外殼及線材顏色: Black / 黑色**

7.2.4 **Vibration and Shock / 振動和衝擊**

The power supply shall be designed to withstand normal transportation vibration per MIL-STD-810D, method 514 and procedures X, as it is mounted in the chassis assembly and packed for shipping.

充電器出貨的包裝設計，均要能承受正常運輸的振動，並符合MIL-STD-810D方法514和程式X。

7.2.5 **Dropping Testing / 跌落試驗:**

**X-Y-Z direction 100cm, one time with each direction**

**X-Y-Z三個方向高度1m每個方向各一次。**

### 8. EMC STANDARDS / 電磁相容性標準

#### 8.1 EMI STANDARDS / EMI 標準

**The power supply met the radiated and conducted emission requirements for FCC CLASS B, EN55032 CLASS B.**

**本充電器符合輻射及傳導要求，滿足FCC CLASS B, EN55032 CLASS B.**

#### 8.2 EMS STANDARDS / EMS 標準

The power supply shall meet the following EMS standards:

本充電器滿足下列EMS標準

<b>EDITION</b>	<b>A</b>	<b>PAGE</b>	<b>5/10</b>
----------------	----------	-------------	-------------

## ELECTRICAL PERFORMANCE / 電器性能

8.2.1 EN61000-4-2: 2009 / A1: 1998 Electrostatic Discharge(ESD)

8.2.2 EN61000-4-3: 2010 / A1: 1998 Radiated Electromagnetic Fields(RS)

8.2.3 EN61000-4-4: 2012 Electrical Fast Transient / Burst(EFT)

8.2.4 EN61000-4-5: 2014 Lighting Surge Attachment. Line to Neutral: 2KV

### 9.RELIABILITY AND QUALITY CONTROL / 可靠性及品質控制

**BURN-IN / 老化** The power supply shall undergo a minimum of 4 hours Burn-In test under full

9.1 **load at 40°C ~ ±5°C.**

充電器應在40°C ~ ±5°C和滿載條件下老化4小時。

9.2 **COMPONENT DERATING / 元件溫度要求** Semiconductor junction temperatures shall not exceed the manufacturer's maximum thermal rating.半導體結溫不允許超過其製造商要求的最大溫度值。

**IELECTRIC WITHSTANDING STRENGTH(HI-POT) / 絕緣介電強度 (耐壓)**

9.3 **Primary to Secondary AC3000V, 10mA, 1 minute for type test, 3 second for production.**

一次側對二次側: AC3000V, 10mA標準測試1分鐘, 量產測試3秒鐘。

10.WEIGHT / 重量 The weight of the power supply shall be about 800 g.. 充電器的重量大約為 800 g

### 11.MECHANICAL REQUIREMENT / 結構參數

The power supply size: L176\*W80\*H47mm.外殼尺寸: L176\*W80\*H47mm

12 **INSULATION RESISTANCE / 絕緣阻抗** Input to output: 50M OHM(500VDC)輸入對輸出50兆歐姆(500VDC)

### 13.LEAKAGE CURRENT / 漏電流

The leakage current shall be **less than 0.25mA for class II** when power supply is operated maximum input voltage and maximum load. 當充電器操作在最大輸入及最大負載情況下, 其漏電流應小於**0.25mA**, 滿足**class II**等級。

### 14.MAJOR MEASURE EQUIPMENT / 主要測量設備; VERIFIED BY THE THIRD LAB/外校

- |   |   |                          |                                     |
|---|---|--------------------------|-------------------------------------|
| A | AC SOURCE / AC變頻電源: 固緯/GWINSTEK APS-7100E,校準頻次: 1次/年                                  | <input type="checkbox"/> | <input checked="" type="checkbox"/> |
| B | DIGITAL POWER METER / 數字功率計功率儀: 固緯/GWINSTEK GPM-8213,校準頻次: 1次/年                       | <input type="checkbox"/> | <input checked="" type="checkbox"/> |
| C | ELECTRONIC LOAD / 開編程電子負載儀: 美爾諾/MAYNUO M9713,校準頻次: 1次/年                               | <input type="checkbox"/> | <input checked="" type="checkbox"/> |
| D | OSCILLOSCOPE / 存儲示波器: 泰科/TEKTRONIX TBS1102B,校準頻次: 1次/年                                | <input type="checkbox"/> | <input checked="" type="checkbox"/> |
| E | DIGITAL MULTIMETER / 數字式萬用表: 福祿克(FLUKE) F12E+校準頻次: 1次/年                               | <input type="checkbox"/> | <input checked="" type="checkbox"/> |
| F | DC POWER / 直流電源: 麥創 (MATRIX) MPS-6030D校準頻次: 1次/年                                      | <input type="checkbox"/> | <input checked="" type="checkbox"/> |
| G | HIPOT AND INSULATION RESISTANCE TESTER / 耐壓安規測試儀:<br>固緯/GWINSTEK GPT-9803 ,校準頻次: 1次/年 | <input type="checkbox"/> | <input checked="" type="checkbox"/> |
| H | INSULATION RESISTANCE TESTER / 絕緣電阻表: YD2681A,校準頻次: 1次/年                              | <input type="checkbox"/> | <input checked="" type="checkbox"/> |
| I | MULTI CHANNEL TEMPERATURE SENSOR / 多路溫度測試儀<br>艾維泰科/IVYTECH IV380-16校準頻次: 1次/年         | <input type="checkbox"/> | <input checked="" type="checkbox"/> |

EDITION	A	PAGE	6/10
---------	---	------	------

PRODUCT OUTLINE DIMENSION / 產品外觀尺寸(mm)

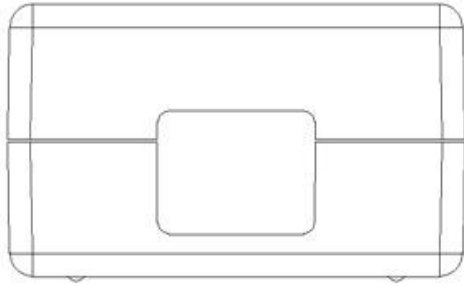

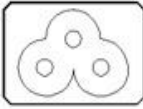
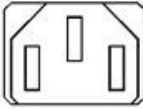
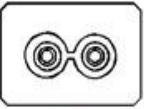
AC Inlet Type	IEC 320-C6	IEC 320-C14	IEC 320-C8
AC入力コネクタ			
AC輸入類型			<input checked="" type="checkbox"/>

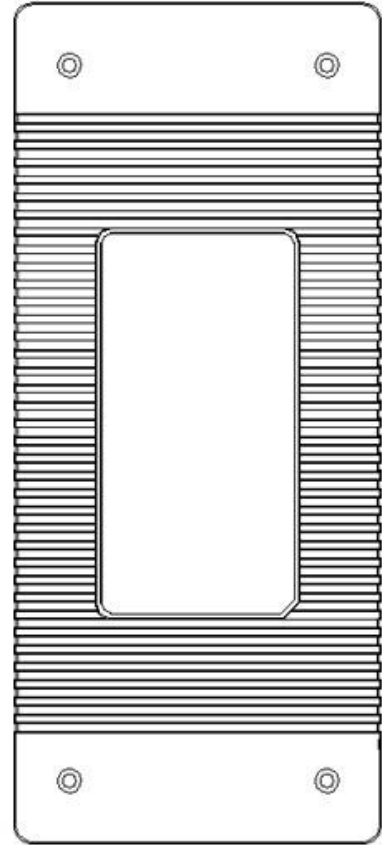
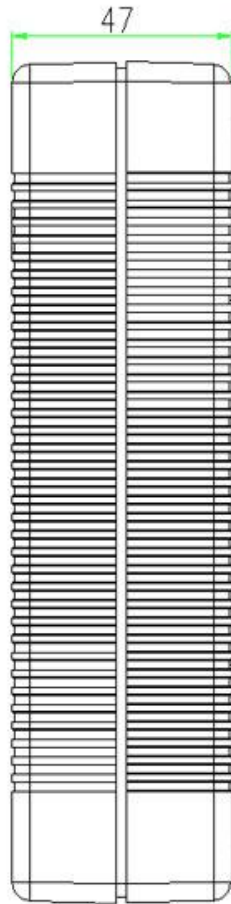
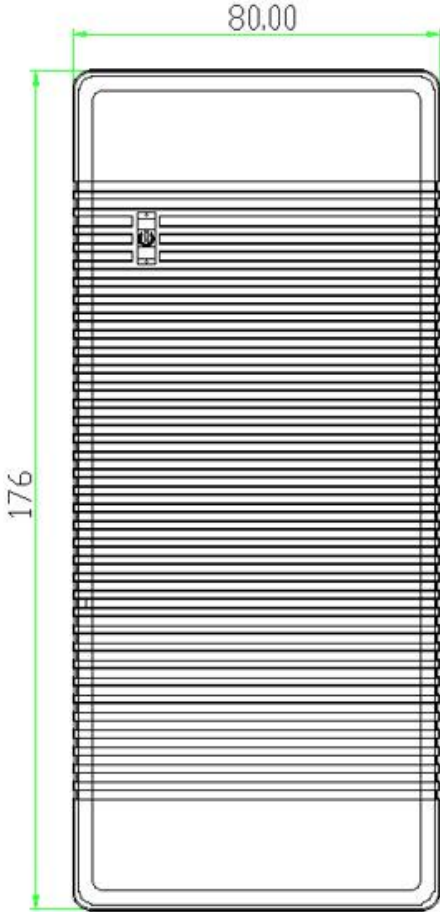

Material/材料: PC

Brand/品牌: SABIC / 沙伯

Fireproof Class/防火等級: UL94V-0

Color/顏色: Black/黑色

EDITION	A	PAGE	7/10
---------	---	------	------

AC CORD / 輸入線材

Version: 版本:	A	Customer: 客户:	鑫聚
Drawing NO: 图号	X16001	Customer P./N.: 客户图号	AC电源线

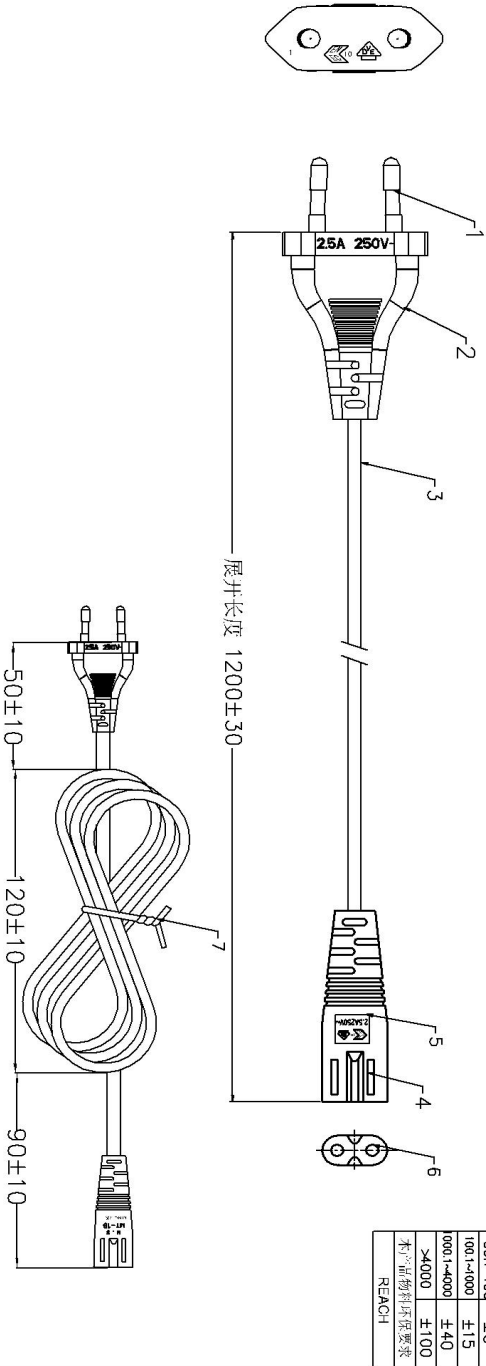

线材 KEMA-KEUR VDE DPEC 60227-5 300/300V HO3VVH2-F 2X0.75mm<sup>2</sup> CABO  
 印字 FLEXVEL PLANO IEMMEQU NEW SQUARE

7	导线规格 (Wire Size)	黑色 包PVC绞线	1	140	
6	插脚规格 (Terminal of end plug)	φ2.35 胡安插脚	2		磷铜色
5	插脚型号 (Type of end plug)	MT-18<2.5A 250V~ENER>	1		黑色
4	插脚内套	八字超内套	1		黑色
3	线材规格 (Cable specification)	VDE HO3VVH2-F 2X0.75mmSQ	1	1185±0	黑色
2	插脚尺寸 (Type of end plug)	MT-11<2.5A 250V~ENER>	1		黑色
1	插脚五金 (Pin of Plug)	欧式固定金	1		镀锌

油印	回印	√
SPECIFICATION	型号 / 规格	COLOR 颜色
MATERIAL	材料	QTY 数量
SIZE	尺寸	REMARK 备注
赣州永德电业制品有限公司 TITLE: 名称 PLUG & WIRE Unit: mm Draw: ZHAN Auditing: 审核 Approve: 核准 2015-10-06		
标记	修改内容	日期



DC CORD / 輸出 線材

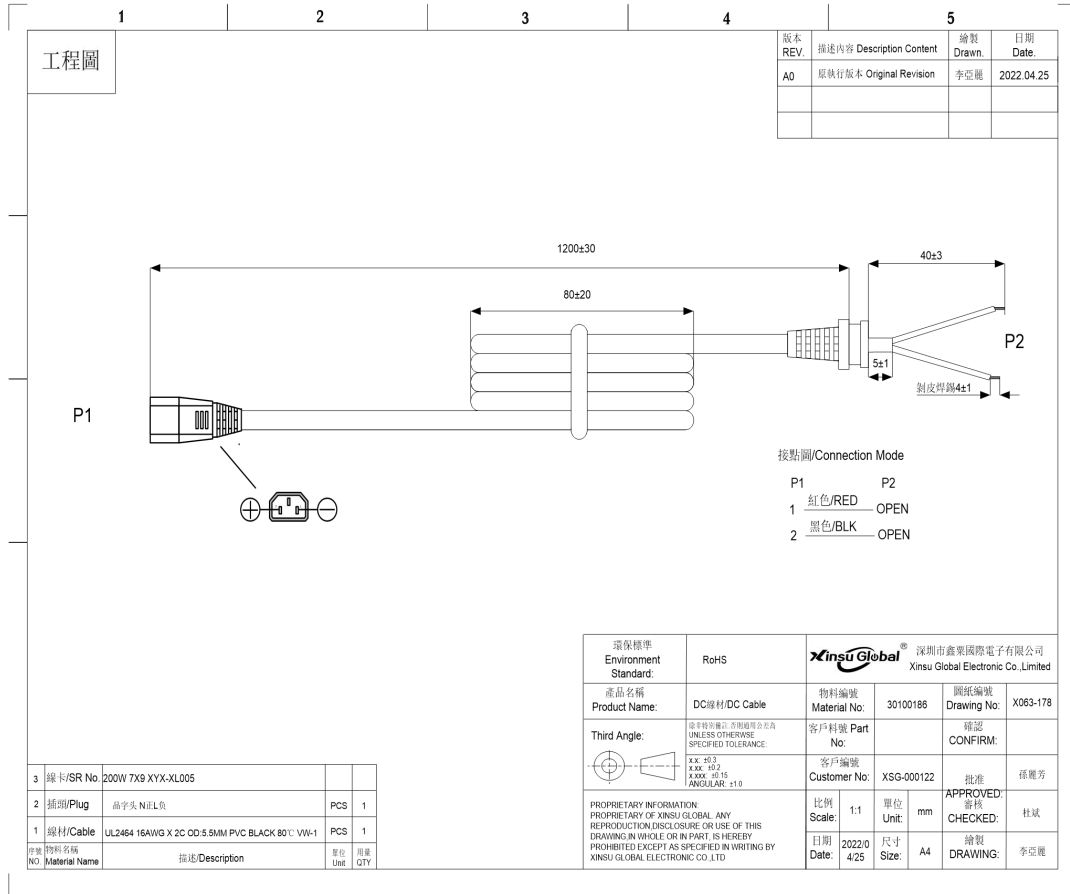

3	線卡/SR No.	200W 7X9 XYX-XL005		
2	插頭/Plug	品字头 N正L負	PCS	1
1	線材/Cable	UL2464 16AWG X 2C OD:5.9MM PVC BLACK 80°C VW-1	PCS	1
序號 NO	物料名稱 Material Name	描述/Description	單位 Unit	數量 QTY

環保標準 Environment Standard:	RoHS	Xinsu Global® 深圳市鑫聚國際電子有限公司 Xinsu Global Electronic Co., Limited		
產品名稱 Product Name:	DC線材/DC Cable	物料編號 Material No:	30100188	圖紙編號 Drawing No:
Third Angle:	客戶料號 Part No:	客戶編號 Customer No:	XSG-000122	圖紙編號 Drawing No:
PROPRIETARY INFORMATION: PROPRIETARY OF XINSU GLOBAL. ANY REPRODUCTION, DISCLOSURE OR USE OF THIS DRAWING IN WHOLE OR IN PART, IS HEREBY PROHIBITED EXCEPT AS SPECIFIED IN WRITING BY XINSU GLOBAL ELECTRONIC CO., LTD.	比例 Scale:	單位 Unit:	mm	圖紙編號 Drawing No:
	日期 Date:	尺寸 Size:	A4	圖紙編號 Drawing No:

Cable Specification/線材規格		
UL2464 Round Wire, 16AWG*2C L=1.2M Black 80°C,300V		
Item No	Part Name ( 部件名稱 )	Description ( 描述 )
A	Length of DC cord(DC線長度)	1200MM
B	Size of DC connector ( DC頭尺寸 )	品字头 N正L負
C	Length of coil ( 線包長度 )	80MM±20
D	SR NO(線卡編號)	XYX-XL003
E	Stripped length(剝皮長度)	40MM±1mm
F	Tinned length ( 吃錫長度 )	4MM±1mm

EDITION	A	PAGE	9/10
---------	---	------	------

RATING LABEL / 銘牌

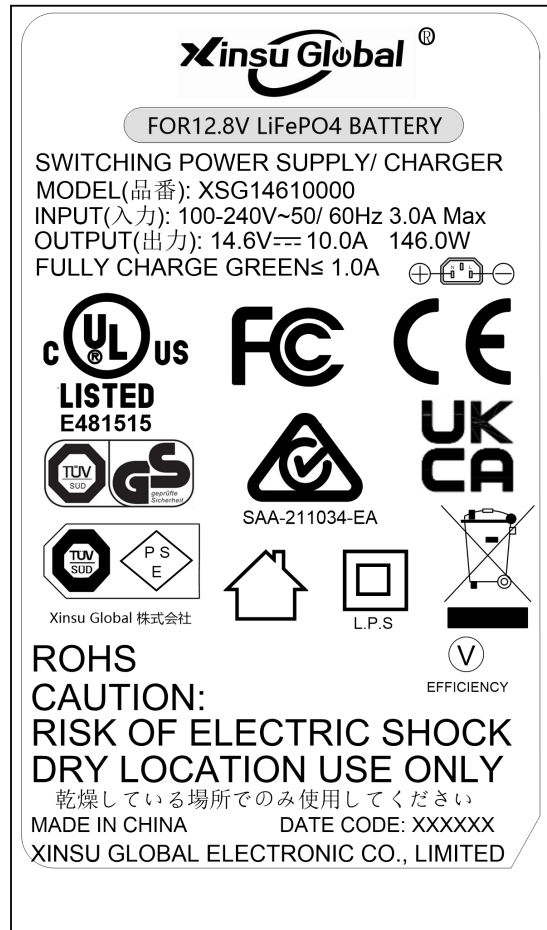

Print/印刷

Laser Carving/鐫雕

- 1.Silver text on black background 黑底銀字
- 2.Material: PET 底材為消銀龍.
3. Clear Printing, Wipe Resistance 絲印清晰, 耐擦拭.product packaging
- 4.Gum Permanent 永久背膠.
- 5.Meet Requirements of Environmental Protection 符合環保要求

EDITION	A	PAGE	10/10
---------	---	------	-------